

HC 2-2 L

Wandhalter für Flachbildschirme

Bracket for Flat Screens

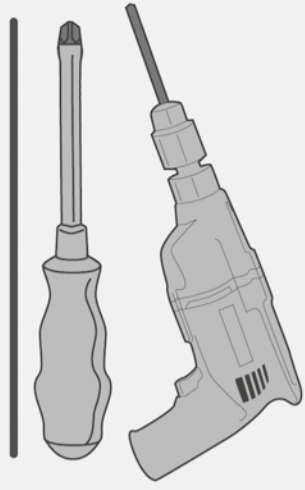

C		(x2)	G		(x8)	M-D		M8x20(x4)	W-A		(x2)
D		(x2)	M-A		M4x14(x4)	M-E		D5(x4)	W-B		(x2)
E		(x2)	M-B		M5x14(x4)	M-F		D8(x4)	I		(x1)
F		(x8)	M-C		M6x14(x4)	M-G		(x8)			

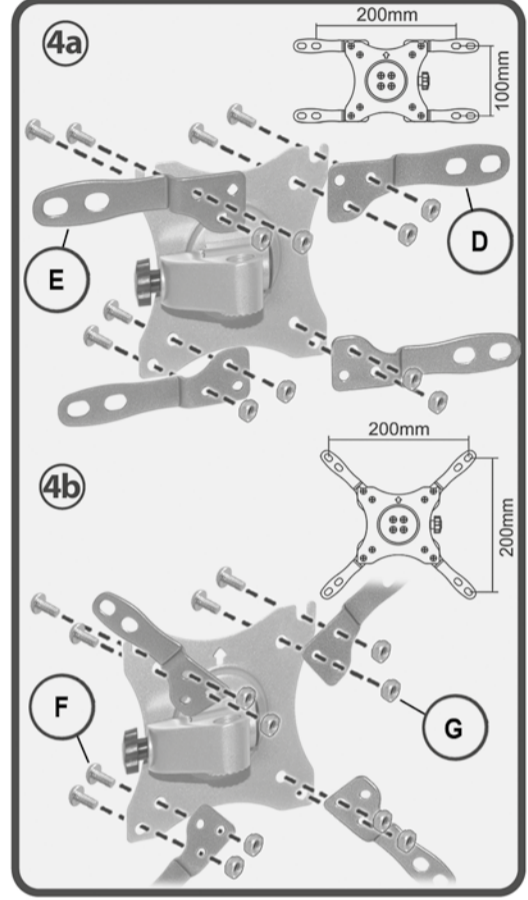
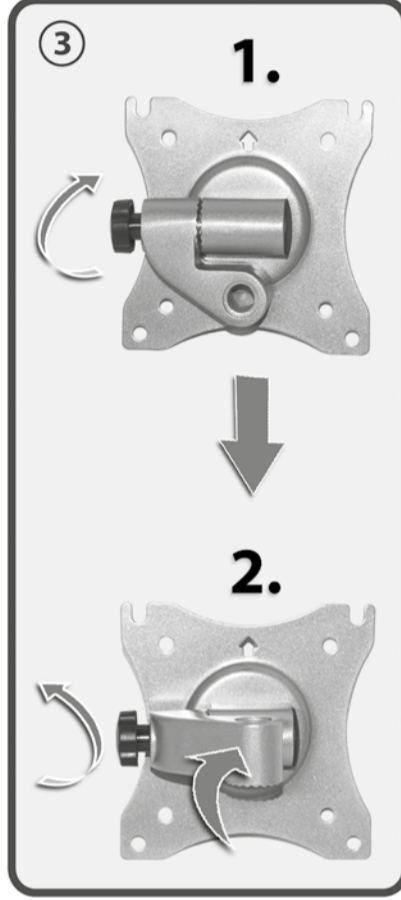
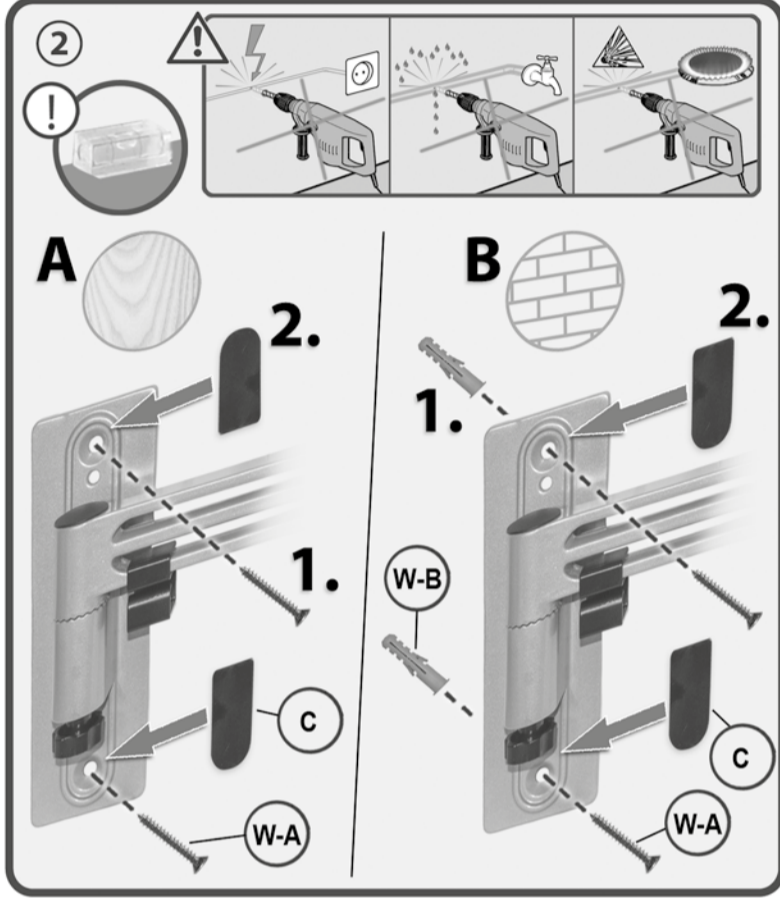
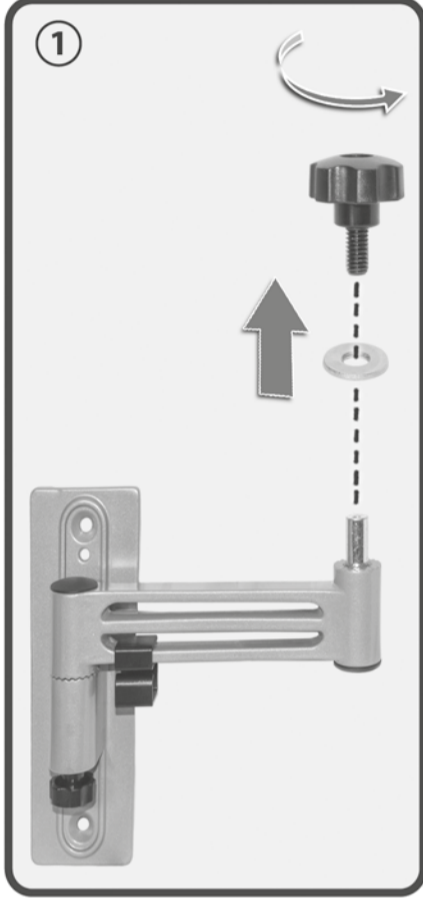

Montageanleitung
 Assembly Instructions
 Instrucciones de montaje
 Návod pro montáž
 Instruções de montagem
 Montaj Rehberi
 Montavimo instrukcija
 Montéringsanvisning
 Paigaldusjuhise
 Asemuohje
 Monteringsvejledning
 Montážas instrukcja
 Istruzioni d'uso
 Monteringsanvisning

HC 2-2 L

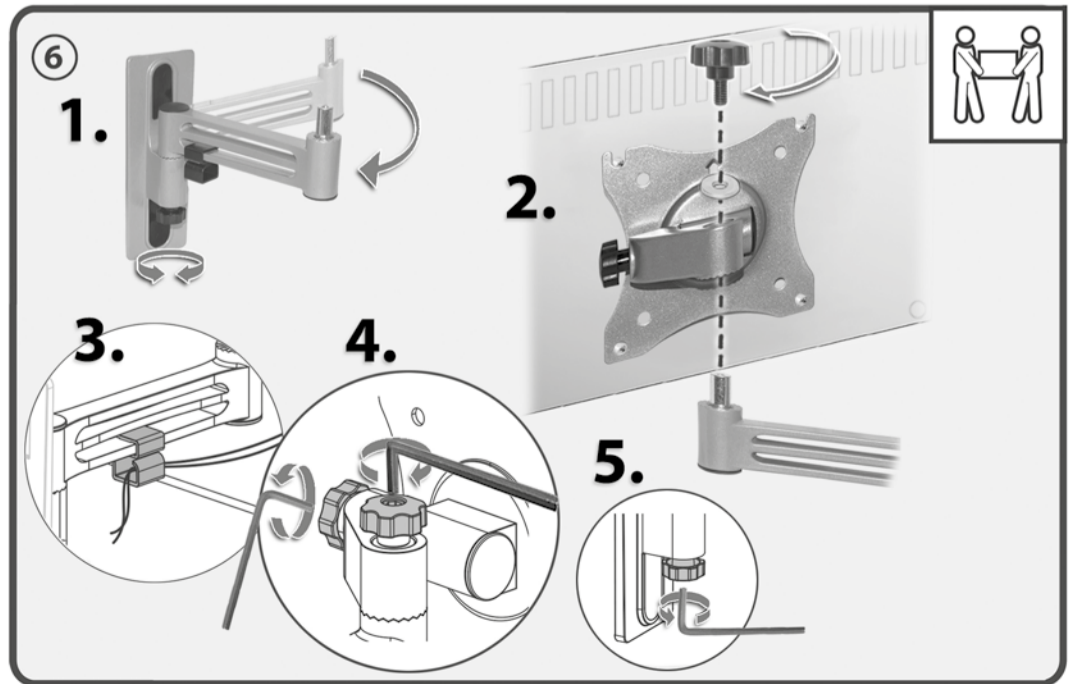
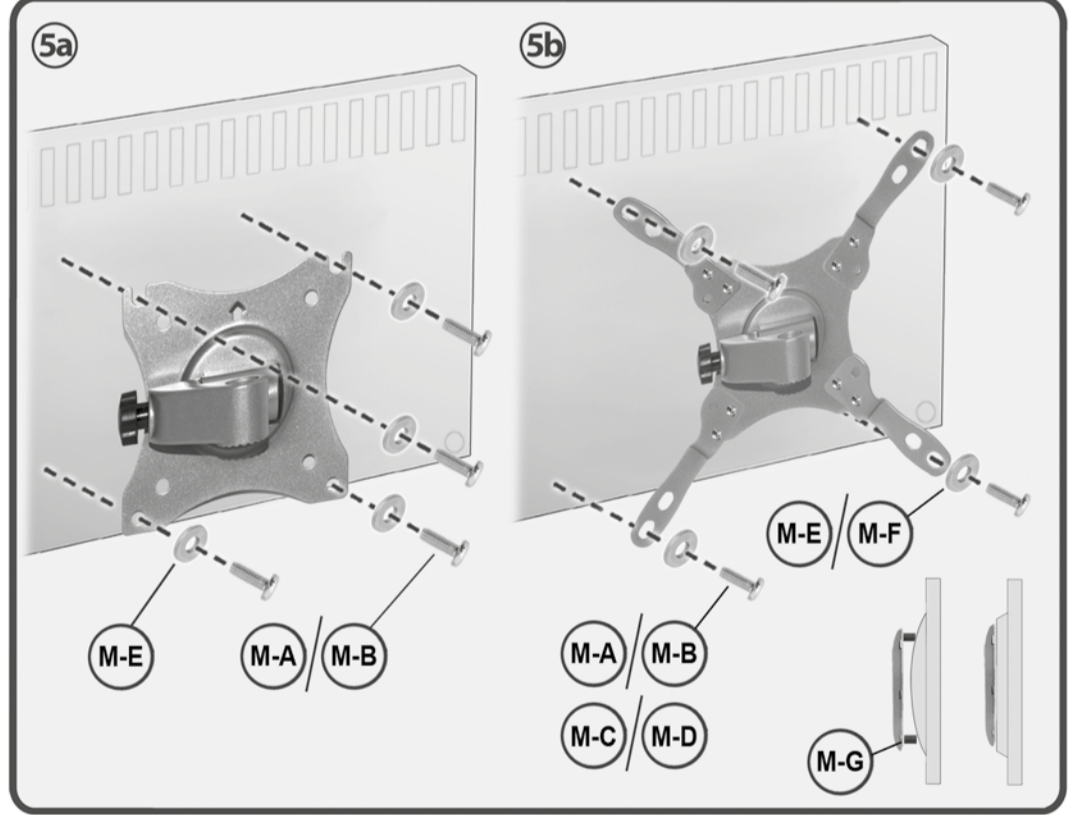

Wandhalter für Flachbildschirme

Bracket for Flat Screens

my wall®
mount accessories

